



255 Valve Specifications



Specifications

Flow Rates (Valve Only)

| | |
|---|-----------------------------------|
| Service @ 15 psi (1.03 bar) drop | 15.5 gpm (3.52 m ³ /h) |
| Backwash @ 25 psi (1.72 bar) drop | 6.0 gpm (1.36 m ³ /h) |
| Service | Cv = 3.99 (Kv = 3.4) |
| Backwash | Cv = 1.20 (Kv = 1.0) |

Note: Tested with a 3/4-inch brass manifold

Valve Connections/Dimensions

| | |
|---|--|
| Tank Thread | 2-1/2-inches – 8, male |
| Inlet/Outlet Manifold (Brass or Noryl®) | 1-inch NPT or BSPT, female 3/4-inch NPT or BSPT, female 3/4-inch NPT or BSPT, male, Noryl® 1/2-inch NPT or BSPT, male, Noryl® |
| Drain Line | 1/2-inch (manifold dependent) |
| Brine Line | 1/4-inch or 3/8-inch NPT, male; air check built into valve |
| Distributor Tube Diameter | 1.050 inches (27 mm) or 13/16-inch (20.6 mm) |
| Distributor Tube Length | 1-1/8 ± 1/8 inches (29 mm ± 3 mm) above top of tank |

Design Specifications/Ratings

| | |
|--------------------------------------|--|
| Valve Body | Glass-filled Noryl® – NSF listed material |
| Rubber Components | Compounded for cold water – NSF listed materials |
| Valve Materials Certification | NSF/ANSI 44 rated component for material safety |
| Weight (Valve with Control) | 4 lbs (1.8 kg) |
| Recommended Operating Pressure | 20 - 120 psi (1.38 - 8.27 bar) |
| Canada | 20 - 100 psi (1.38 - 6.89 bar) |
| Hydrostatic Test Pressure | 300 psi (20.69 bar) |
| Water Temperature | 35° - 100°F (2° - 38°C) |
| Ambient Temperature* | 35° - 120°F (2° - 48.9°C) |

*Recommended use of outdoor cover for direct sunlight applications

Options

| | |
|--------------------------------|---|
| Turbine for Demand Units | Standard manifold, 1-inch Autotrol turbine |
| Bypass Valve | Noryl®, 1-inch flow path, 1/2-inch (13mm) NPT male, drain |

Bypass Inlet-Outlet Fitting Kits:

| | |
|--|---|
| Copper, Sweat Tube Adapter | 1-inch or 3/4-inch (25 mm or 19 mm) |
| CPVC, Solvent Weld Tube Adapter | 1-inch or 3/4-inch (25 mm or 19 mm) |
| Plastic NPT or BSPT Pipe Adapter | 1-inch male or 3/4-inch male (25 mm or 19 mm) |
| Brass NPT or BSPT Pipe Adapter | 1-inch male or 3/4-inch male (25 mm or 19 mm) |
| Brine Refill Controls | .33 gpm (1.25 Lpm) fixed .17 gpm (.64 Lpm) fixed – optional for small tank applications 1-10 lbs (0.45 - 4.5 kg) – 400 series controllers 3-19 lbs (1.3 - 8.6 kg) – 400 series controllers |

| | |
|---|--|
| Compatible with Regenerants/Chemicals | Sodium chloride, potassium chloride, potassium permanganate, sodium bisulfite [†] , sodium hydroxide [†] , hydrochloric acid [†] , chlorine ^{††} and chloramines ^{††} |
|---|--|

[†] See owners manual for specific concentrations

^{††} Valve for use on potable water supply

Injector* Performance – Logix Series Controllers

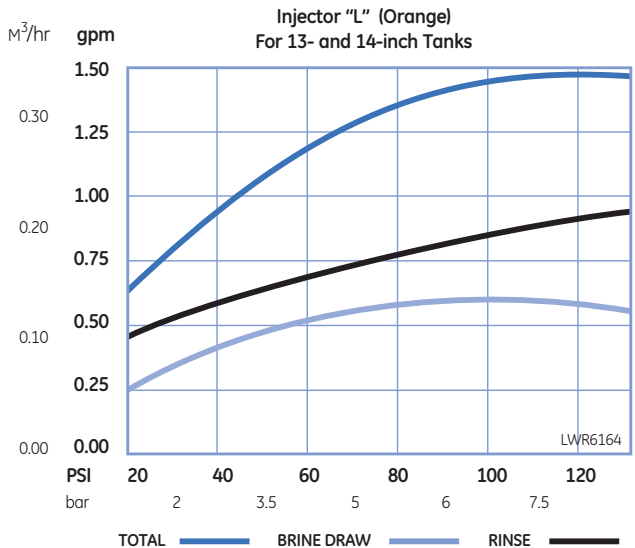
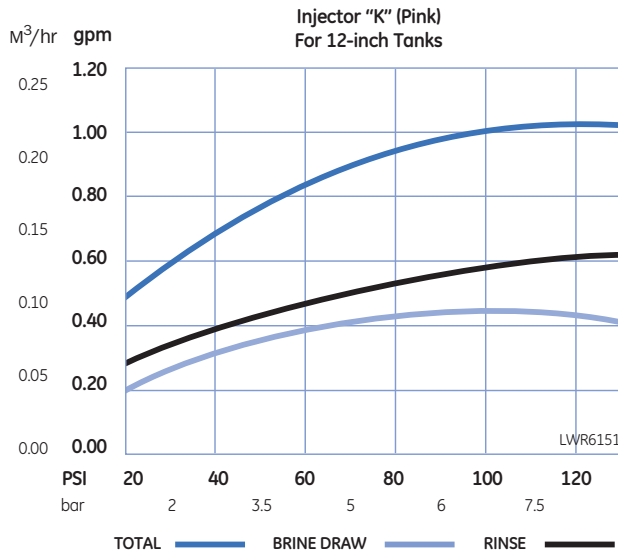
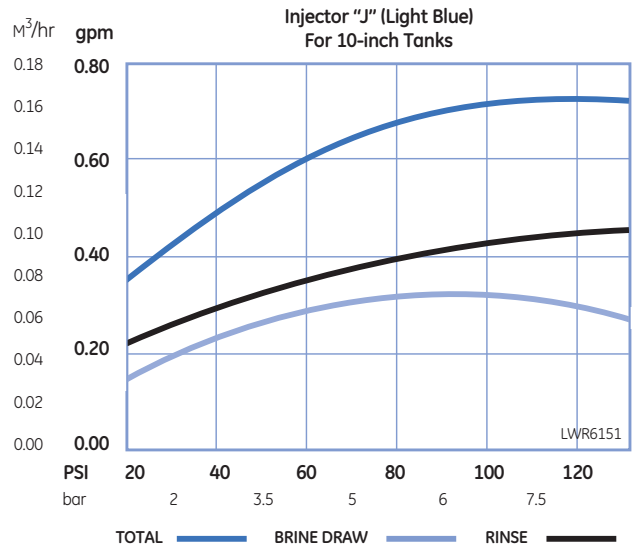
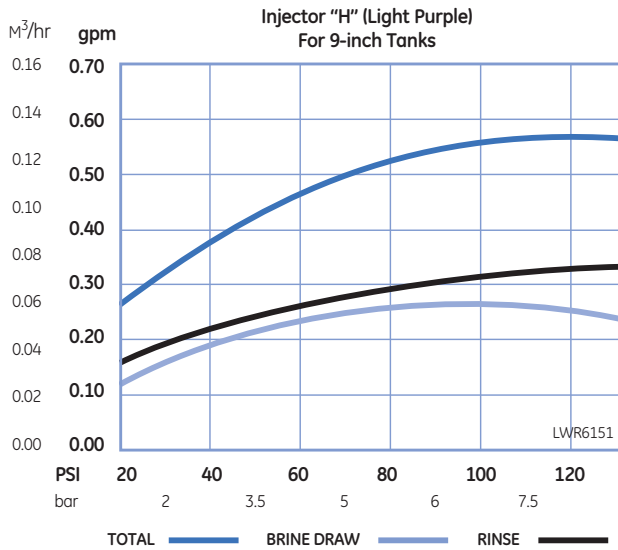
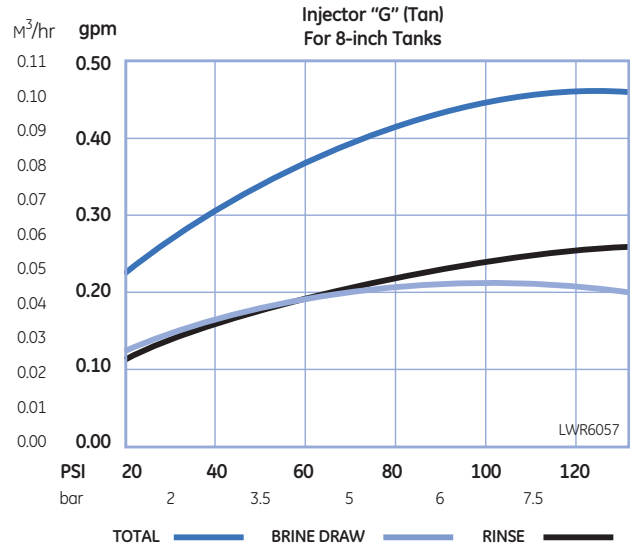
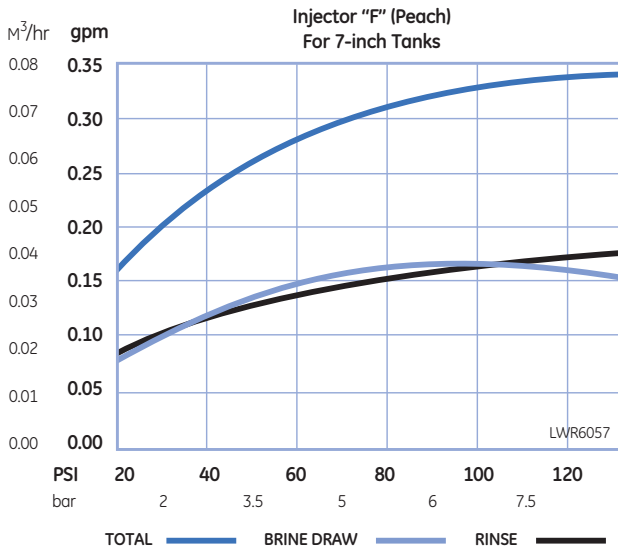

*New injectors for high-efficiency regeneration sequence are standard with Logix Controllers.

NOTE: Actual injector performance is dependent on the resin used, tank geometry, elevated drain, etc. This injector data was taken using an empty tank (no resin).

400 and 900 Series Controllers

Flow Rate Characteristics

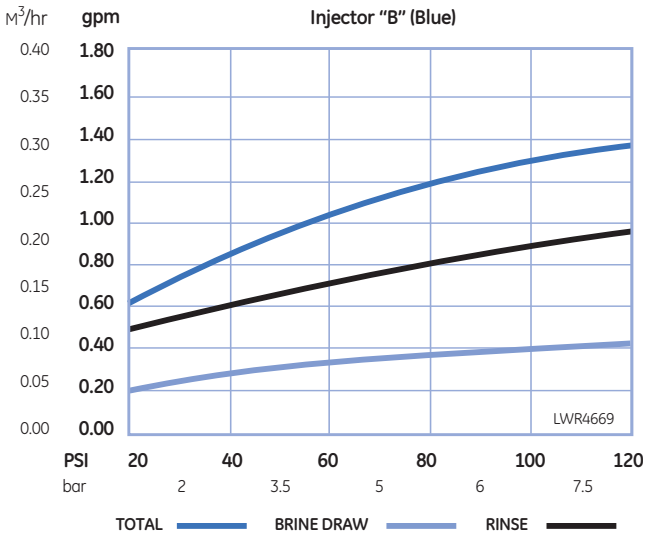
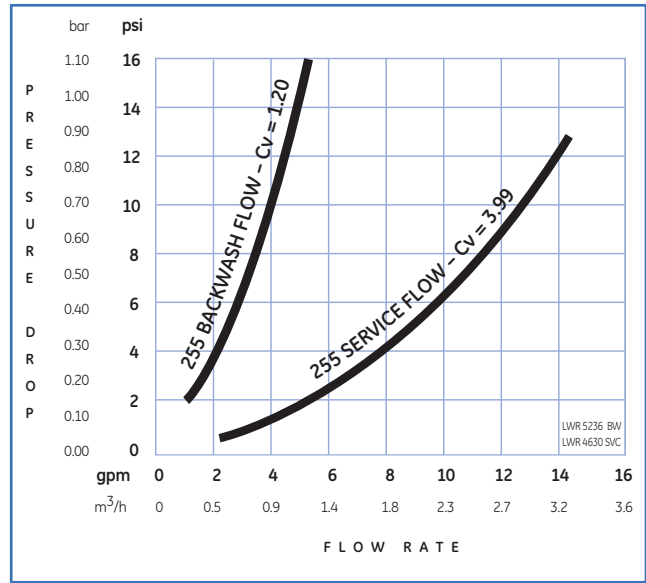
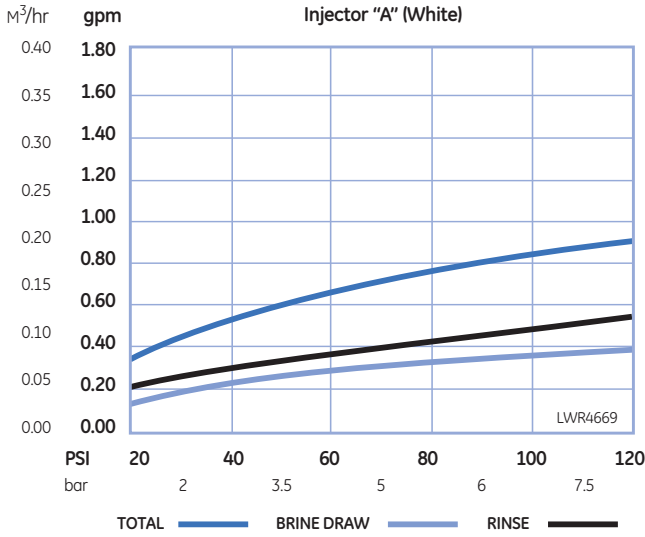

Backwash Flow Control Table

| Backwash Number** | Flow Rate (gpm) | Flow Rate (lpm) |
|-------------------|-----------------|-----------------|
| 7 | 1.3 | 4.9 |
| 8 | 1.7 | 6.4 |
| 9 | 2.2 | 8.3 |
| 10 | 2.7 | 10.2 |
| 12 | 3.9 | 14.76 |
| 13 | 4.5 | 17.0 |
| 14 | 5.3 | 20.0 |

**Backwash flow controls sized for 5.0 gpm/ft²

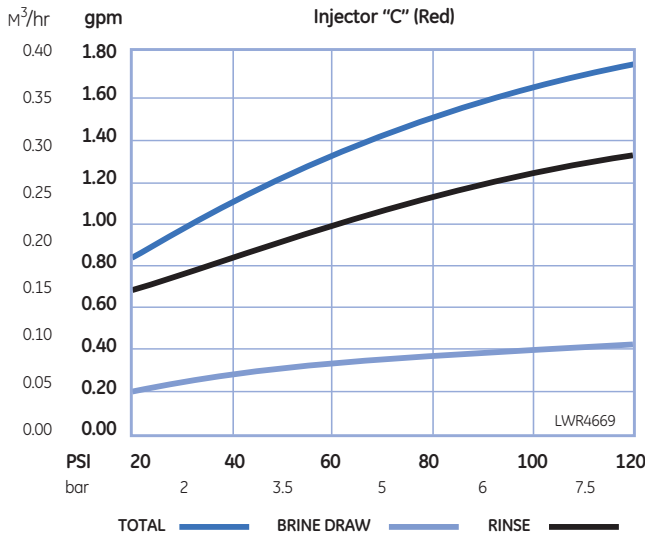

Controller Series

GE offers a full range of valve controllers to meet all residential water-conditioning applications.

Logix Series

740 Time Clock

- Simple, economic electronic time clock (chronometric)
- 7- or 99-day regeneration setting
- High efficiency regeneration sequence
- 12-volt operation
- Filter or conditioner setting in one control
- Operates 255, 263, 268 with one controller



760 Demand

- Simple, economic electronic demand (volumetric)
- Calendar override
- 12-volt operation
- 28-day variable reserve
- High efficiency regeneration sequence
- Automatic capacity calculations
- Operates 255, 263, 268 with one controller



742 Time Clock

Same features as the 740 time clock, plus:

- Fully programmable cycle times
- Salt setting in 1-pound increments
- Optional no-salt detector
- Operates 255, 263, 268, 278, and Magnum IT with one controller

762 Demand

Same features as the 760, plus:

- Fully programmable cycle times
- Salt setting in 1-pound increments
- Optional no-salt detector
- Operates 255, 263, 268, 278, and Magnum IT with one controller

400 Series

440i Time Clock

- Value priced, reliable mechanical control
- Time-clock regeneration
- Set it and forget it
- 12-volt or 120-volt versions available
- 6- or 7-day regeneration
- Operates 255, 263, 268 valves



460i Time Clock

- Economical electronic-demand control
- Simple set-up and programming
- Calendar override
- 12-volt operation
- 7-day variable reserve
- Operates 255, 268 valves









Electrical Specifications

| | |
|--|---|
| Controller Operating Voltage | 12 Volt – AC (Requires use of GE Infrastructure supplied transformer) |
| Input Supply Frequency | 50 or 60 Hz (Controller configuration dependent) |
| Motor Input Voltage | 12 Volt – AC |
| Electronics Operating Voltage (Logix Series) | 3.5 Volt – AC |
| Controller System Power Consumption | 3 Watts average |

Transformer Specifications – All Controllers

All Controllers require the use of a GE Infrastructure supplied transformer.

| | |
|----------------------------|--|
| Transformer Output Voltage | 12 Volt – AC 400mA |
| Transformer Input Options | 115 Volt – AC 50/60 Hz; 230 Volt – AC 50/60 Hz; 100 Volt – AC 50/60 Hz |
| Transformer Plug Options | Indoor North American Plug  |
| | Outdoor North American (UL Listed for outdoor use)  |
| | Japanese Plug  |
| | Taiwan/Korea Plug  |
| | Australian Plug  |
| | United Kingdom Plug  |
| | Mainland Europe Plug  |
| | Additional transformers may be available – call for more information |

Controller valve manufactured by:

North American Sales
5730 N. Glen Park Road
Milwaukee, WI
53209-4403
USA

For More Information:
Call Krudico
308 E 4th St
Auburn, IA 51433-7718
(712) 688-2284
or visit www.krudico.com

255 Valve Outline Dimensions

Logix Series Controllers

255 Valve Dimensions with Logix Cover

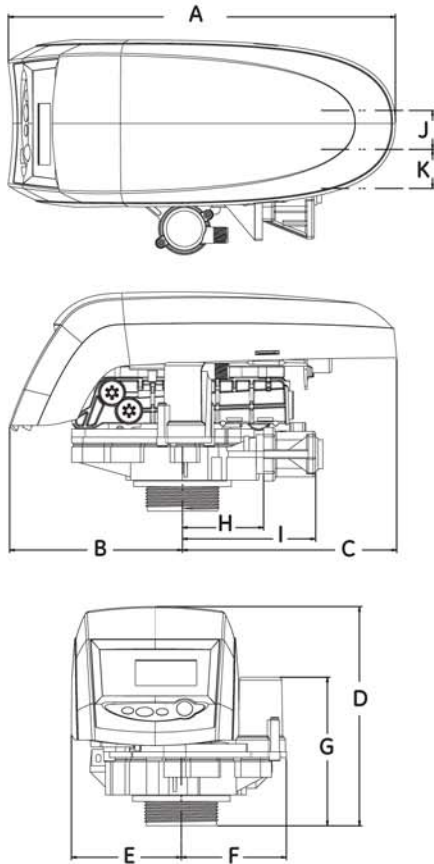

400 Series Controllers

255 Valve Dimensions with 400 Series Controller

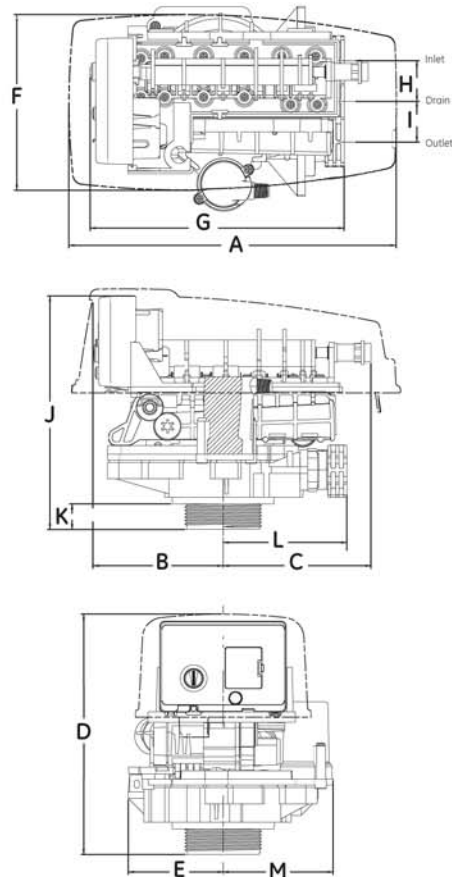

255 Valve – Logix Series Controller

| | in | cm | | in | cm |
|---|------|--------|---|-----|--------|
| A | 14.9 | (37.8) | G | 5.7 | (34.5) |
| B | 6.6 | (16.8) | H | 3.1 | (7.9) |
| C | 8.2 | (20.8) | I | 5.1 | (13.0) |
| D | 8.4 | (21.3) | J | 1.5 | (3.8) |
| E | 4.2 | (10.7) | K | 1.5 | (3.8) |
| F | 4.0 | (10.2) | | | |

255 Valve – 400 Series Controller

| | in | cm | | in | cm |
|---|-------|--------|---|------|--------|
| A | 12.07 | (30.6) | G | 9.36 | (23.8) |
| B | 4.80 | (12.2) | H | 1.50 | (3.8) |
| C | 5.44 | (13.8) | I | 1.50 | (3.8) |
| D | 8.86 | (22.5) | J | 8.60 | (21.8) |
| E | 3.50 | (8.9) | K | .94 | (2.4) |
| F | 6.48 | (16.5) | L | 4.56 | (11.6) |

